

Effective transport for non-conveyable parcels in distribution centers

Roller Plates (Machined and Molded)



The challenge of oversized and non-standard items

Rising e-commerce sales mean that distribution centers face a significant increase in the number of irregularly shaped, non-conveyable packages that are difficult to transport. Products such as tires, carpets, hoses, and totes require special logistical handling in the warehouse. The manual cart systems currently used are inefficient and pose safety issues, while belting solutions can bring drawbacks that include high weights and sorting problems.

To help you solve this growing problem, Habasit has developed roller plates that are easy to install, adjust and repair. Based on rolling friction, they solve many issues with irregularly shaped packages and non-standard items.

New solution ensures easier, cost-saving transport

Every gravity chute has a unique configuration, and is customized to the application. To cope with this, we offer two types of plates:

- Machined plates cut to size to fit into position, which need a specific roller orientation
- Molded plates for standard, straight-run gravity chutes

Both versions are often used on the same chute line, and since the molded and machined plate roller heights are identical, they can be used together without any application issues.

This system provides simple and effective transport automation, unlike manual transportation by carts, and there is no need for electrical energy. It also reduces manual work (no moving or lifting of parcels on and off carts). As a result, it delivers measurable cost savings and reduces potential injuries.

The roller plates can be used in many applications besides gravity chutes, including lift gates, skate wheel replacements, and sidewalls.

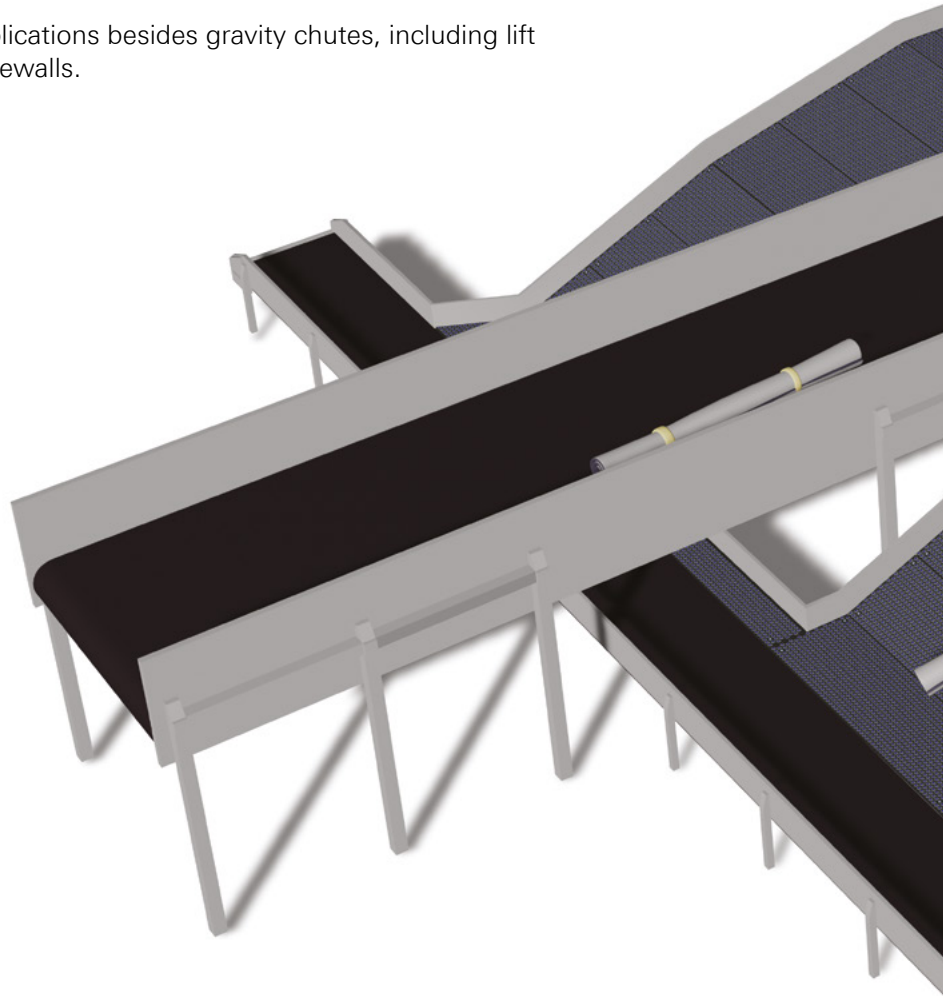
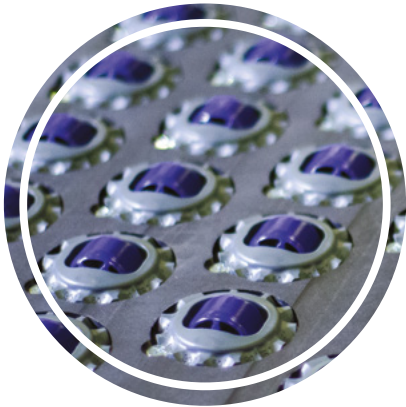
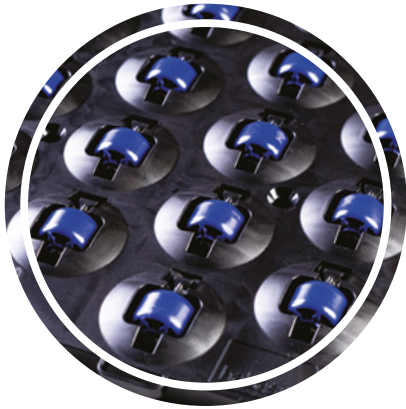

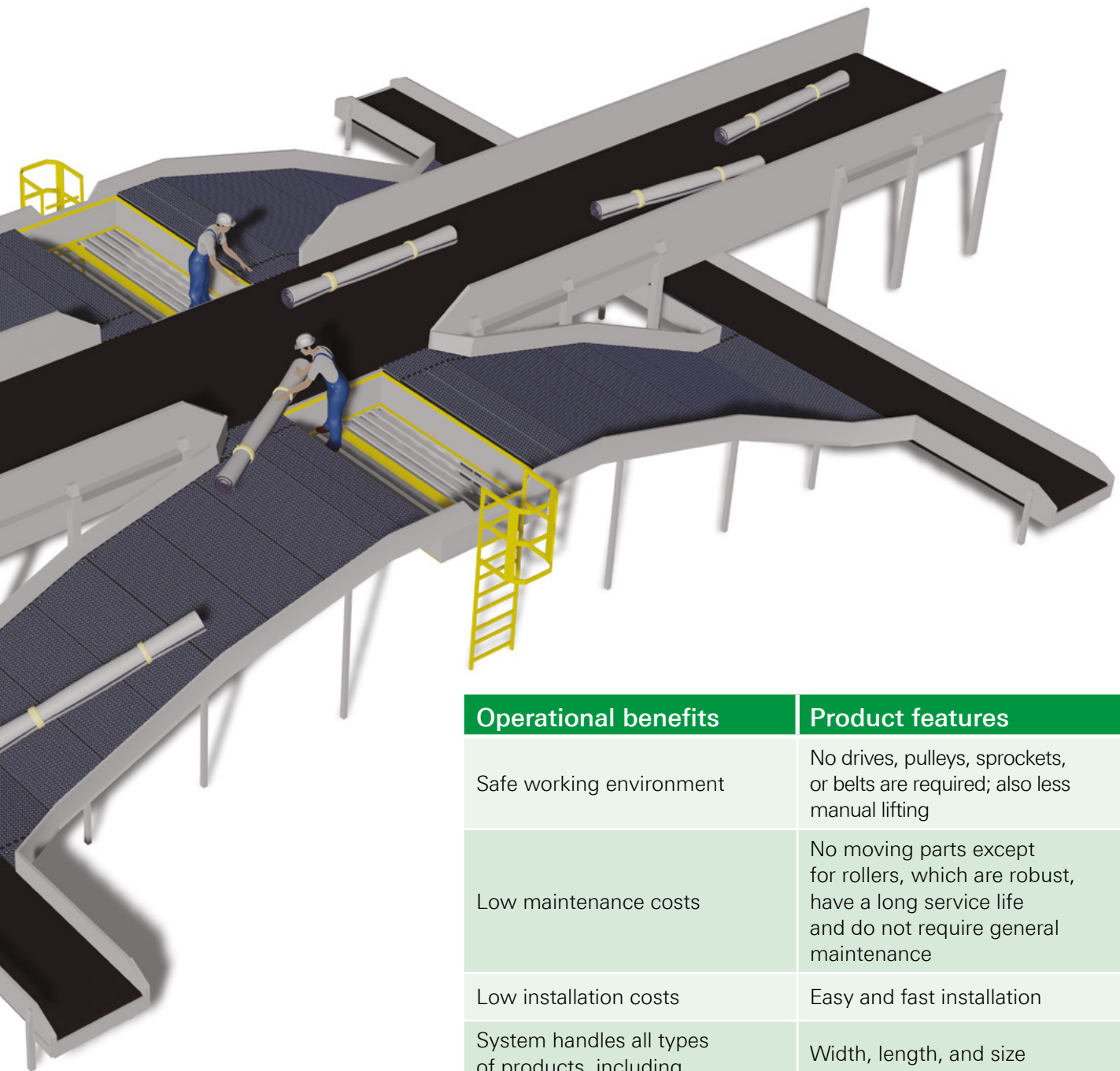

Operational benefits	Product features
Safe working environment	No drives, pulleys, sprockets, or belts are required; also less manual lifting
Low maintenance costs	No moving parts except for rollers, which are robust, have a long service life and do not require general maintenance
Low installation costs	Easy and fast installation
System handles all types of products, including oversized items	Width, length, and size can be customized
Can change direction as required	Orientable rollers can direct products to the center or side
Reduced downtime	Robust structure of the roller plates ensures reliable operation. Roller or plate replacement is easy, further reducing downtime

Machined roller plates



Easy maintenance – Any broken parts are easy to repair from the top by simply removing the screw, pulling out the broken roller, and installing a new one. This saves maintenance time and costs.

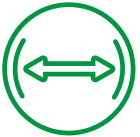

Tailored to size – Habasit roller plates are cut to size, with no need for field adjustments. This means a better physical appearance and less work. Each plate is attached by sliding it over two pins; no bolts are required.



Flexibility – Rollers can be assembled with different orientations to change the direction of the products as required.

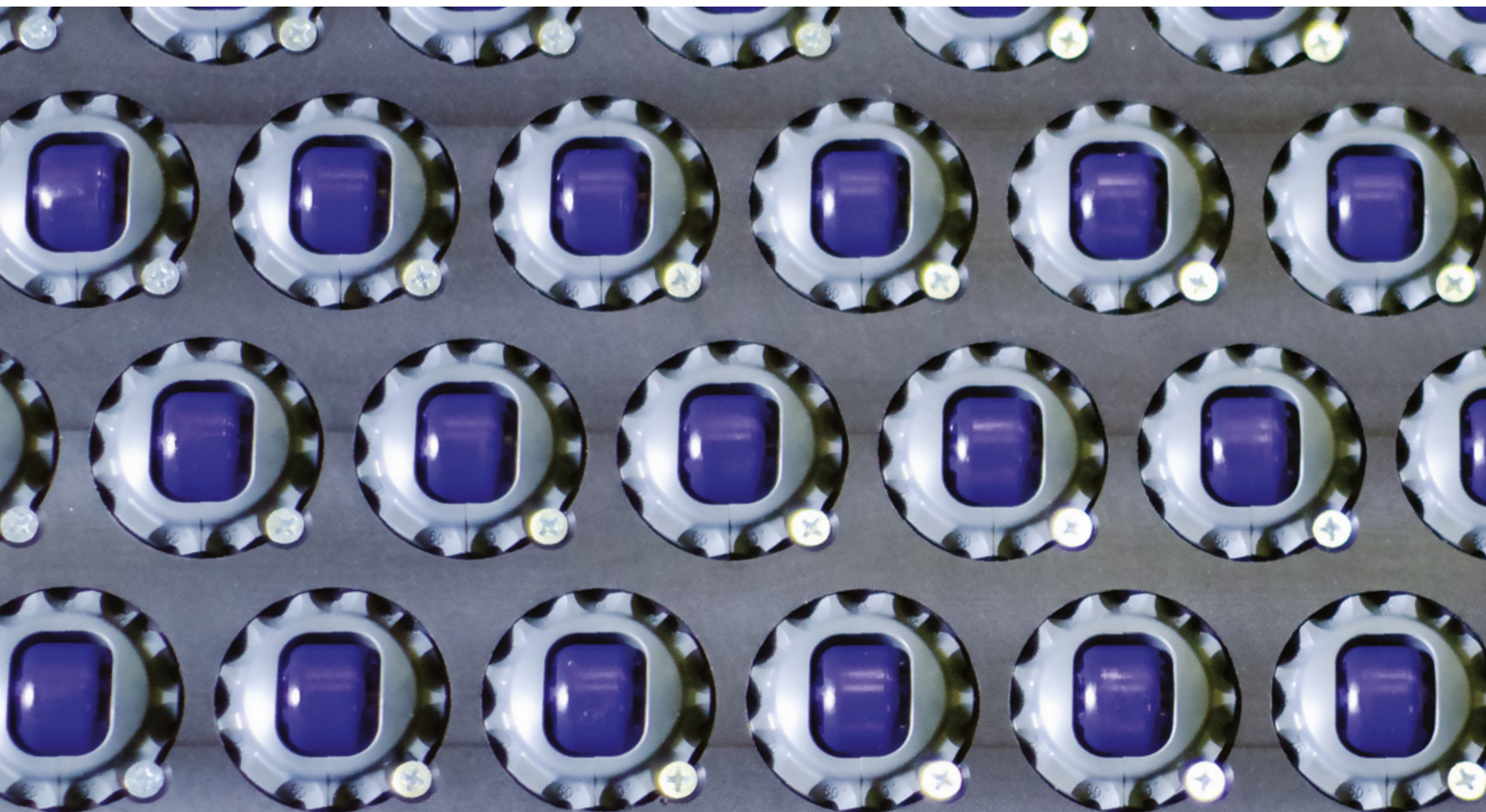

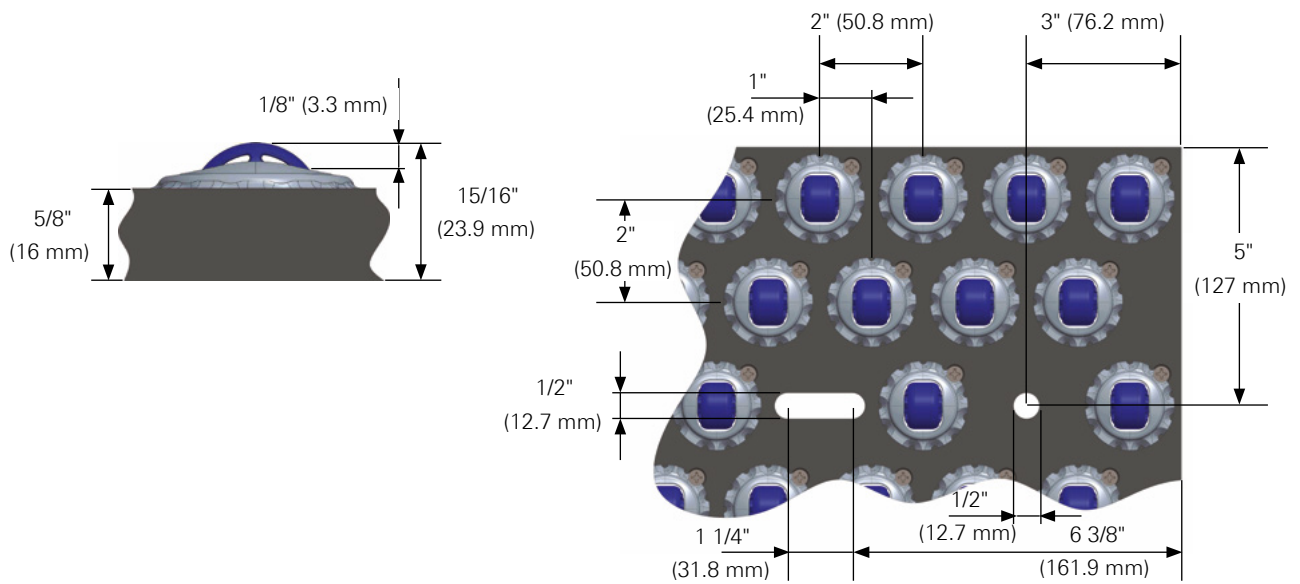

- The maximum machined size is 4' x 10' (1219 mm x 3048 mm) – in any shape required, cut to size (multiple sheets)
- Machined plates have an adjustable roller orientation of 0°- 90° in 15-degree increments

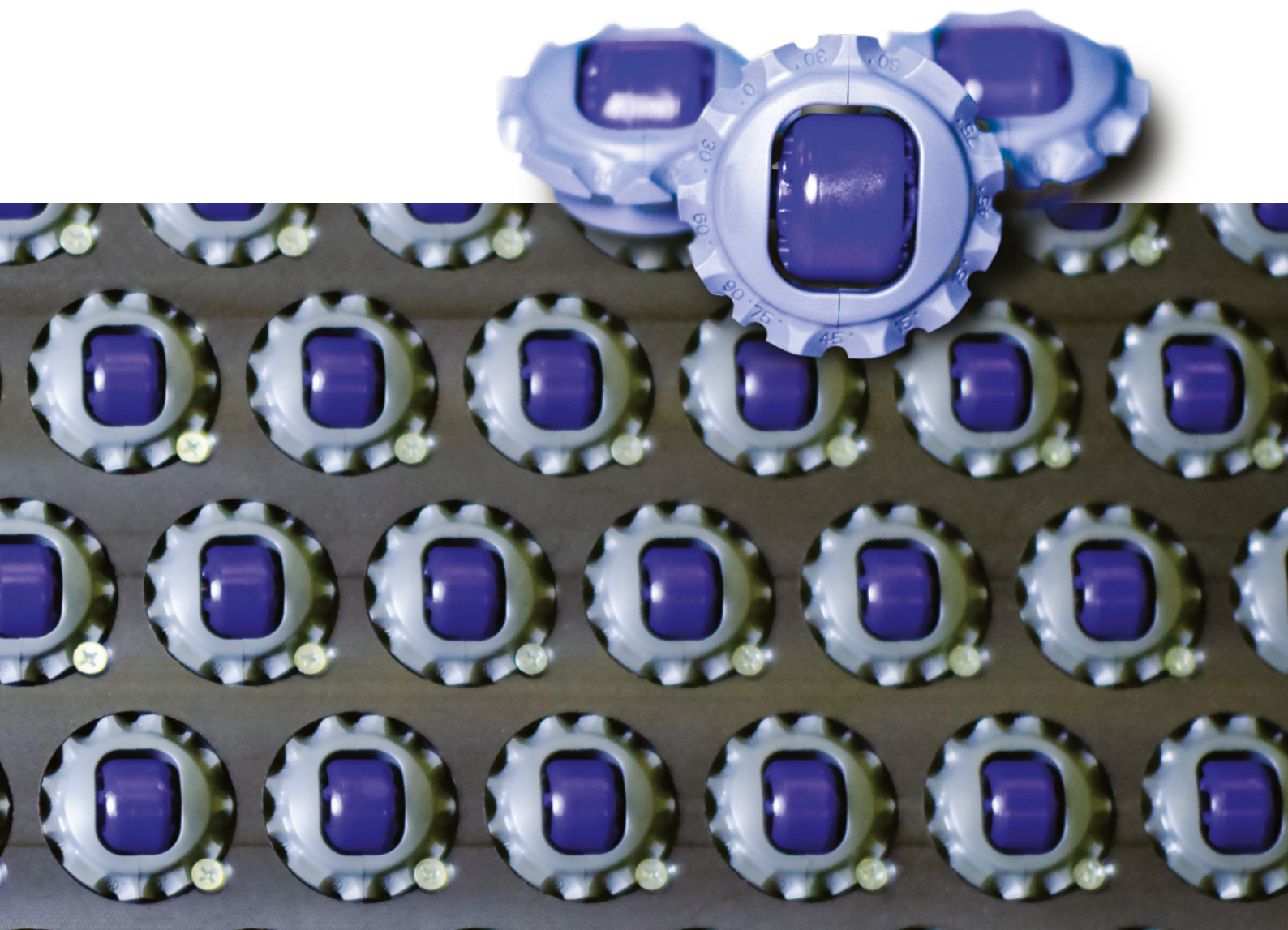

Molded roller plates



Easy repair and replacement – Molded roller plates are easy to install and repair, and are ideal for handling non-conveyable packages.



Short delivery lead time – Habasit molded plates are shipped from stock, to get you moving as quickly as possible.



Standard size – Molded plates are available in standard sizes, which makes chute design easy and installation as simple as laying floor tiles.

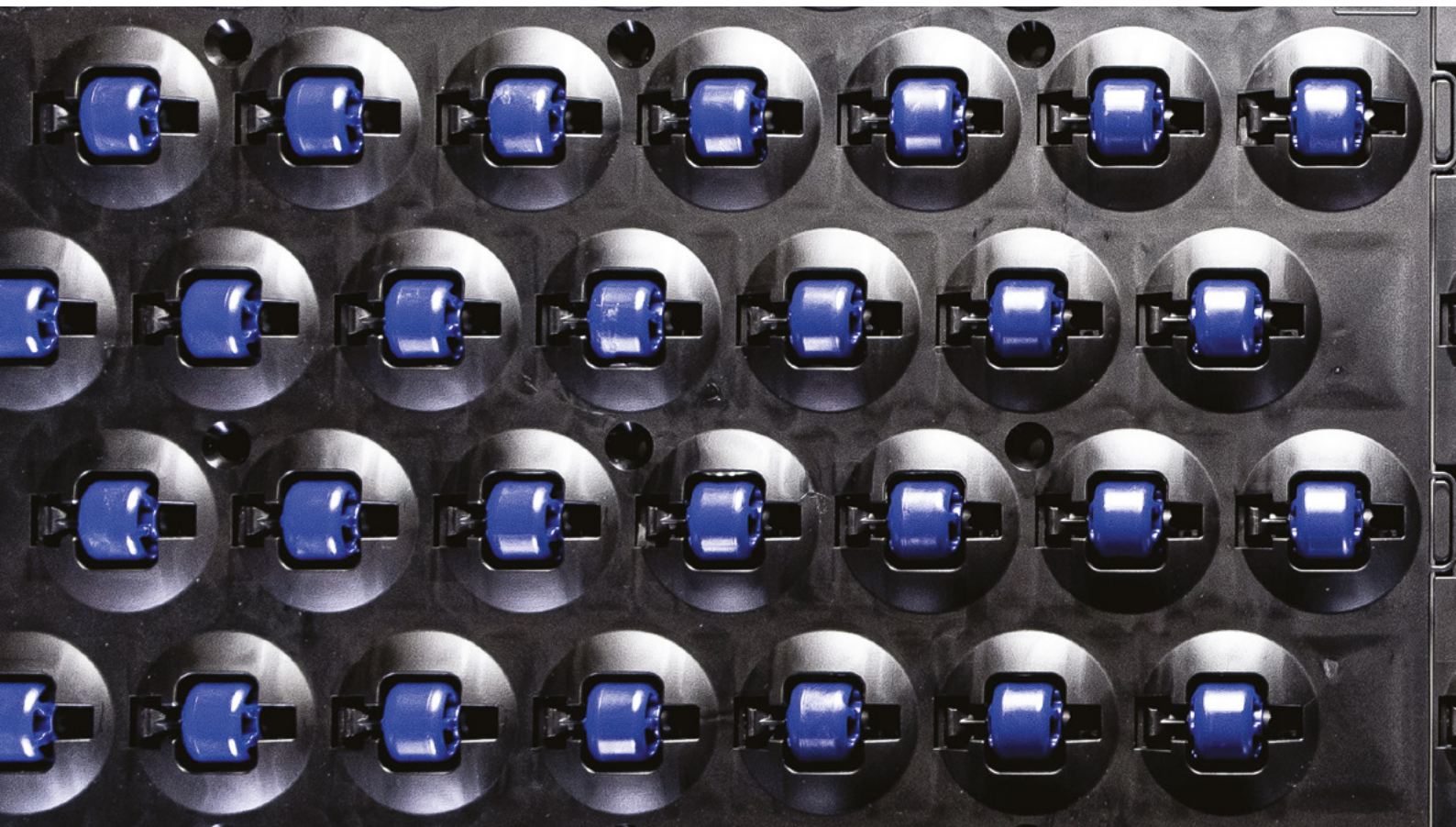

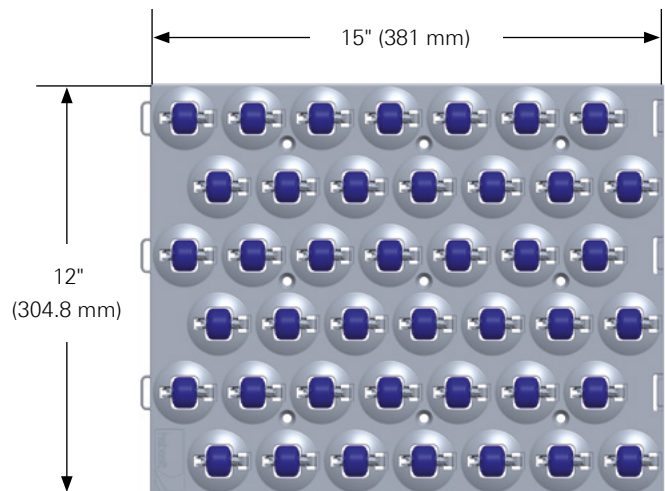
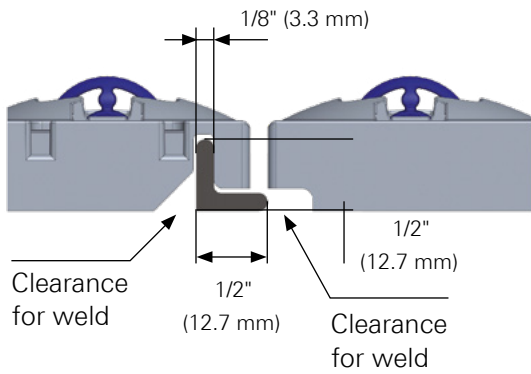

Standard Widths Available (no cutting)									
Plate width (meter/feet)	m	0.38	0.76	1.14	1.52	1.91	2.29	2.67	3
	ft	1.25	2.5	3.75	5	6.25	7.5	8.75	10
Plate width (millimeter/inch)	mm	381	762	1143	1524	1905	2286	2667	3048
	in	15	30	45	60	75	90	105	120
Frame width (millimeter/inch)	mm	406	787	1168	1549	1930	2311	2962	3073
	in	16	31	46	61	76	91	106	121

- Molded roller plates can handle package weights up to 200 pounds/sqft (975 kg/m²)
- Molded plates have a fixed roller orientation of 0° straight down

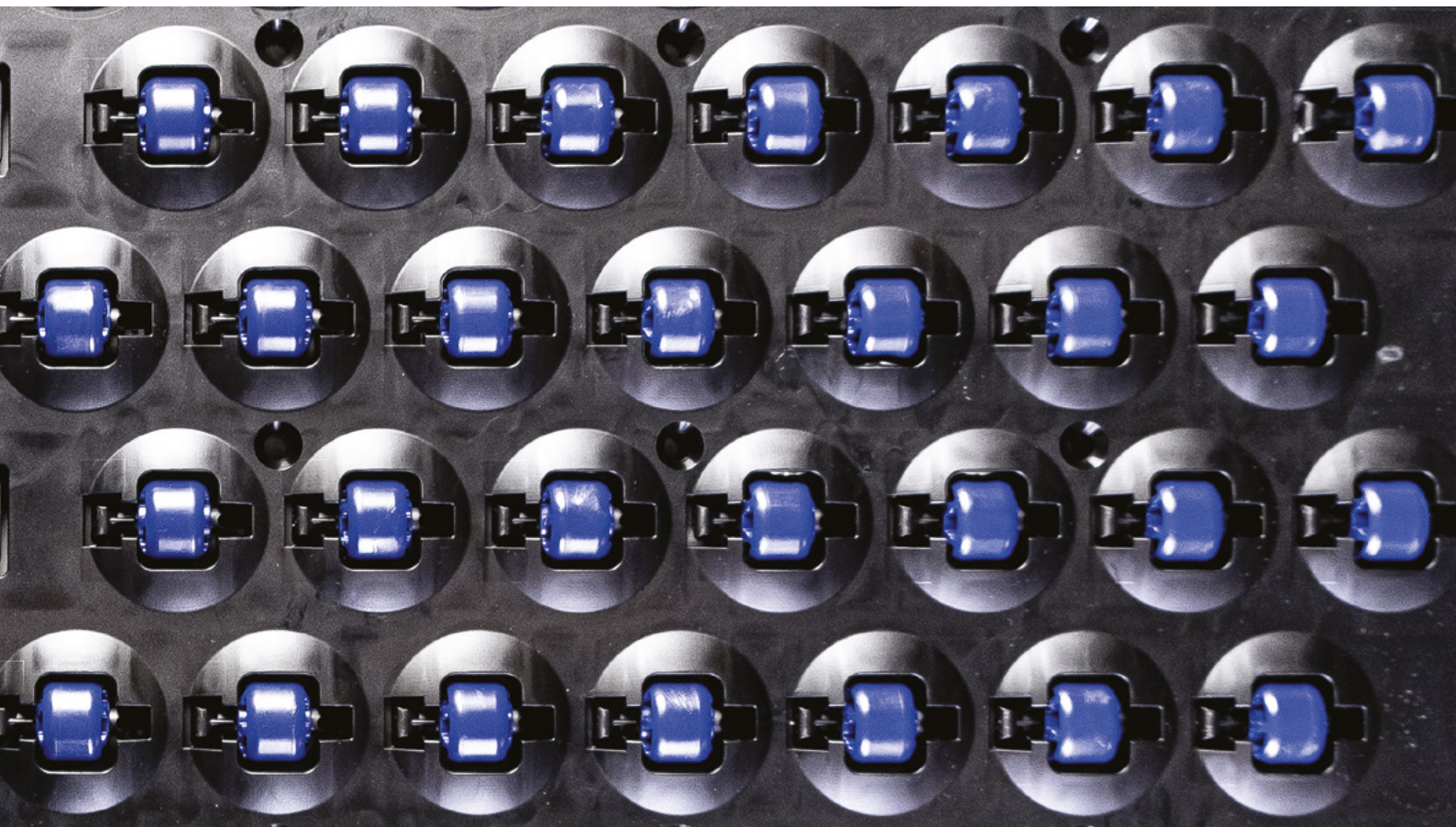





Habasit International AG

Römerstrasse 1
CH-4153 Reinach, Switzerland

 +41 61 715 15 15

 +41 61 715 15 55

 habasit.com

Registered trademarks

Copyright Habasit International AG

Subject to alterations

4534FLY.MOD-en0422HQR

Information provided herein does not constitute legal representations or warranties and may change without notice.

Please refer to the specifications/disclaimers provided in the respective product data sheets.

